

# DermaInspect<sup>®</sup> CARS - MPT

CARS / multiphoton tomograph

*In vivo* optical biopsies with chemical fingerprints based on near infrared femtosecond laser technology for:

- detection of lipids and water
- melanoma detection
- diagnosis of dermatological disorders
- tissue engineering
- cosmetic research, skin aging
- *in situ* drug monitoring
- animal research studies
- stem cell research
- detection of fluorescent proteins

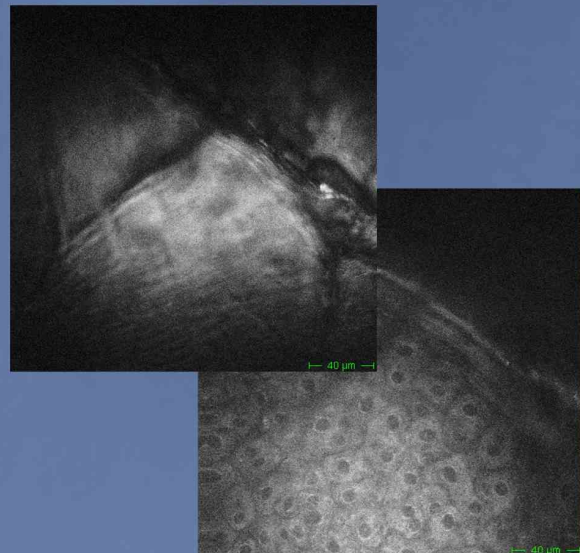
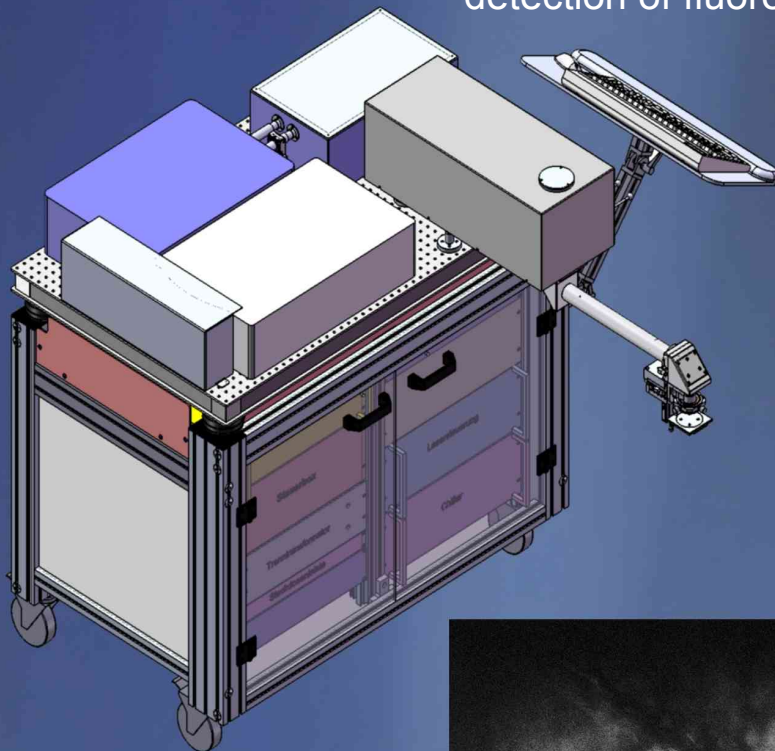

# Coherent Anti-Stokes Raman Spectroscopy (CARS) - Multiphoton Tomography (MPT)

## Product description

The DermalInspect® CARS - MPT is a CE-certified medical tomograph based on femtosecond multiphoton excitation of fluorescent biomolecules like NAD(P)H, flavins, porphyrins, elastin, melanin and additionally on the generation of CARS signals of water and lipids. The extracellular matrix protein collagen can be identified by its second harmonic generation (SHG). Autofluorescence, SHG and CARS signals are simultaneously recorded by fast PMT detectors with single photon sensitivity. The tomograph consists of a compact, turn-key tunable femtosecond near infrared (NIR) laser, an optical parametrical oscillator (OPO), a beam-scanning module with galvoscaners and piezo-driven optics, a two-PMT-detector module as well as a control unit including JenLab Image software for image processing. Additional modules for two-photon *in vivo* FLIM as well as two-photon microendoscopy can be provided.

## Applications

The major application is early diagnosis of skin diseases such as malignant melanoma and psoriasis. Using innovative non-invasive multiphoton and CARS technology the physician obtains optical biopsies with detailed information on living cells and tissue structures within their physiological environment. Dermatological disorders can be detected with submicron spatial resolution. The image acquisition time is less than 20 seconds per frame. The novel tomograph DermalInspect® CARS - MPT has the potential to revolutionize the conventional invasive time consuming diagnostic procedures. The multiphoton / CARS tomograph can also be used in tissue engineering and wound healing studies as well as in cosmetic and pharmaceutical research. The efficiency of anti-aging products as well as the biosafety of sunscreen nanoparticles can be tested *in vivo*. Furthermore, the skin age can be evaluated by measuring the ratio of elastin to collagen.

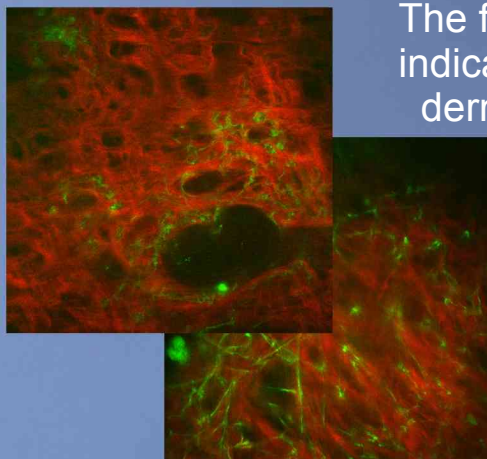

The false-color overlay of two images indicates morphological structures of dermal layers: autofluorescence of elastin and collagen crosslinks (green) and collagen (red).

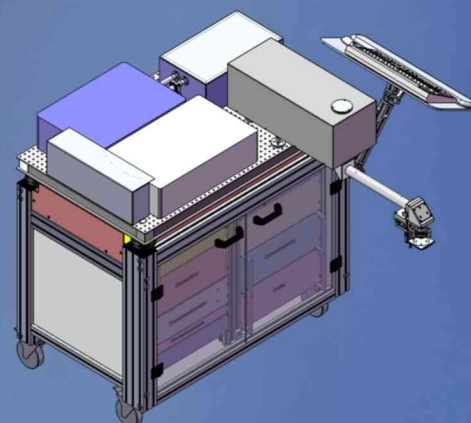

# Coherent Anti-Stokes Raman Spectroscopy (CARS) - Multiphoton Tomography (MPT)

## Optical biopsies

Tomographic images of epidermal layers at different depths. The false-color overlay of two images indicates morphological structures of cells (autofluorescence=green) and collagen (SHG=red).

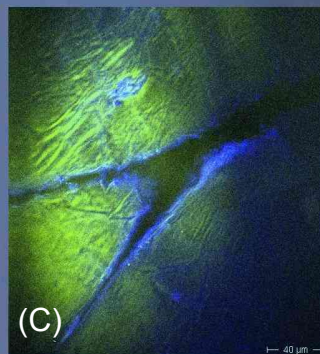
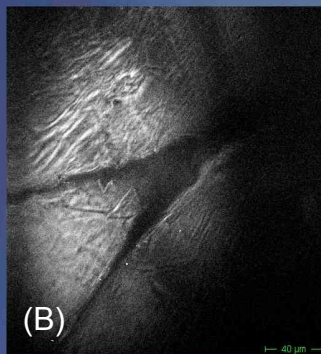
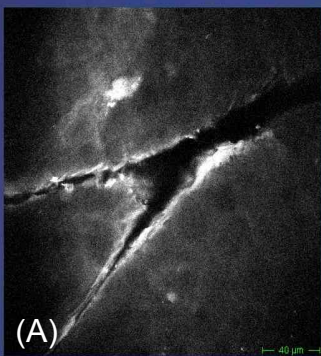
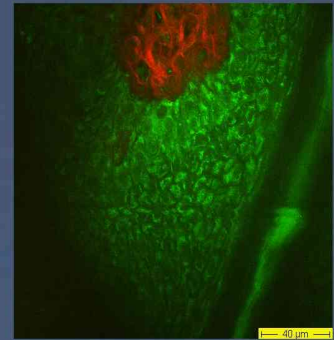
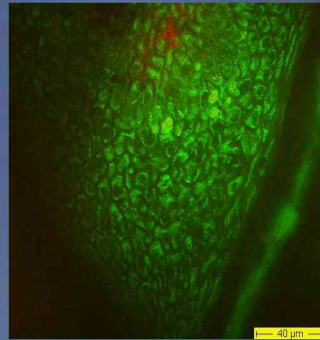
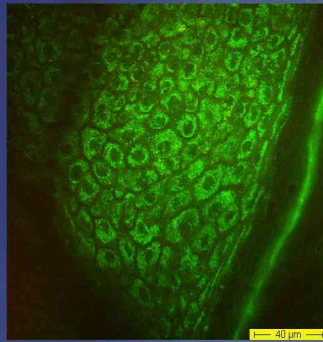
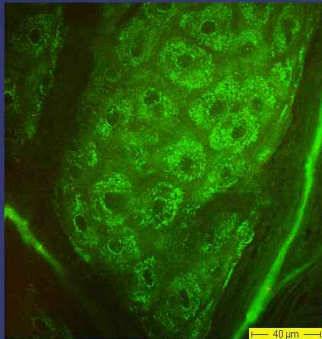

Images of epidermal layers: autofluorescence (A) and CARS image of lipid structures (B). The false-color overlay of both images (C): autofluorescence (blue) and CARS signal from lipids (green).

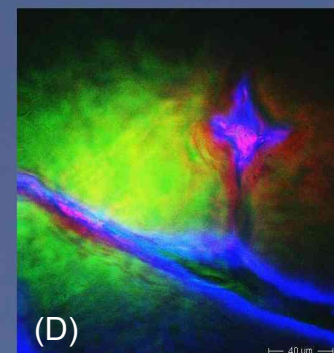
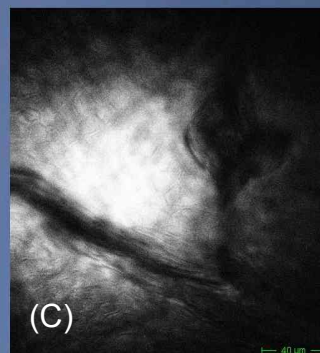
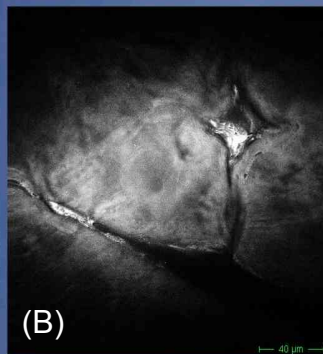
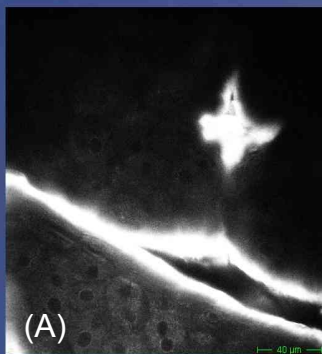

Images of epidermal layers: autofluorescence (A) CARS image of lipid structures (B) and CARS-image from water (C). The false-color overlay of the three images (D): autofluorescence (blue), CARS signal from lipids (red) and CARS-signal from water (green).

## Technical data

- compact turn-key tunable Ti:Sapphire femtosecond laser  
laser pulse width: 200 fs  
repetition frequency: 80 MHz  
in situ laser power: 2-50 mW  
wavelength range. 710-920 nm
- compact turn-key optical parametrical oscillator (OPO) pumped by Ti:Sapphire laser highly efficient frequency transformation from the Ti:Sapphire range (740 to 880 nm) to 1000 ... 1600 nm (signal)
- optionally the OPO can be replaced by a wavelength extension unit for broadband supercontinuum generation
- full-frame scanning, region-of-interest (ROI) scanning, line scanning, single-point illumination (spot scan)
- typical scan range: 350  $\mu\text{m}$  x 350  $\mu\text{m}$  (horizontal); 200  $\mu\text{m}$  (vertical)
- spatial resolution: < 0.5  $\mu\text{m}$  (horizontal); < 2  $\mu\text{m}$  (vertical)
- focusing optics: magnification 40x NA 1.3
- control and image processing software (JenLab Scan, JenLab Image)
- operating temperature 15-35°C
- relative humidity: 5-65 %
- power requirements: 230 VAC (50 Hz) or 115 VAC (60 Hz)
- CE certified class 1M /IIa medical product
- 1200 mm x 780 mm x 1100 mm, 350 kg

The system requires an air-conditioned room with reduced ambient light.

These specifications are subject to change without notice.



JenLab GmbH  
Johann-Hittorf-Strasse 8  
12489 Berlin, Germany  
Phone: +49 30 63927740  
Fax: +49 30 63927744  
E-Mail: [info@jenlab.de](mailto:info@jenlab.de)  
[www.jenlab.de](http://www.jenlab.de)

